



T-NETWORK

Figure 1 shows a T network.

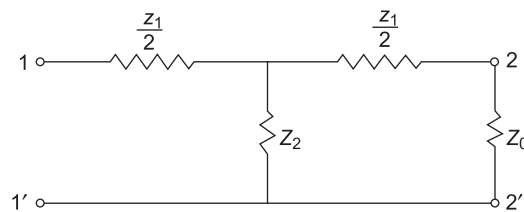

Fig. 1

Characteristic Impedance

For T network, the value of input impedance when it is terminated by characteristic impedance z_0 , is given by

$$z_{\text{in}} = \frac{z_1}{2} + \frac{z_2 \left(\frac{z_1}{2} + z_0 \right)}{\frac{z_1}{2} + z_2 + z_0}$$

But

$$z_{\text{in}} = z_0$$

$$\begin{aligned} z_0 &= \frac{z_1}{2} + \frac{2z_2 \left(\frac{z_1}{2} + z_0 \right)}{z_1 + 2z_2 + 2z_0} \\ &= \frac{z_1}{2} + \frac{(z_1 z_2 + 2z_2 z_0)}{z_1 + 2z_2 + 2z_0} \end{aligned}$$

$$= \frac{z_1^2 + 2z_1z_2 + 2z_1z_0 + 2z_1z_2 + 4z_0z_2}{2(z_1 + 2z_2 + 2z_0)}$$

$$4z_0^2 = z_1^2 + 4z_1z_2$$

$$z_0^2 = \frac{z_1^2}{4} + z_1z_2$$

$$z_0 = \sqrt{\frac{z_1^2}{4} + z_1z_2}$$

Hence characteristic impedance for symmetrical T section is given by,

$$z_{OT} = \sqrt{\frac{z_1^2}{4} + z_1z_2}$$

Characteristic impedance can also be expressed in terms of open circuit impedance z_{OC} and short-circuit impedance z_{SC} .

Open circuit impedance $z_{OC} = \frac{z_1}{2} + z_2$

Short circuit impedance $z_{SC} = \frac{z_1}{2} + \frac{\frac{z_1}{2} z_2}{\frac{z_1}{2} + z_2}$

$$= \frac{z_1}{2} + \frac{z_1 z_2}{z_1 + 2z_2}$$

$$= \frac{z_1^2 + 4z_1 z_2}{2z_1 + 4z_2}$$

$$z_{OC} z_{SC} = \left(\frac{z_1 + 2z_2}{2} \right) \left(\frac{z_1^2 + 4z_1 z_2}{2z_1 + 4z_2} \right)$$

$$= \frac{z_1^2}{4} + z_1 z_2 = z_{OT}^2$$

$$z_{OT} = \sqrt{z_{OC} z_{SC}}$$

Propagation Constant

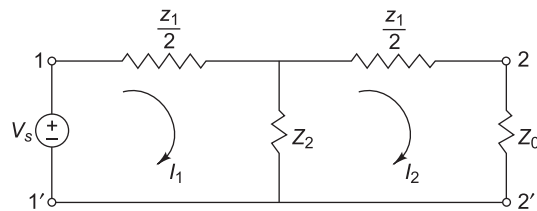

Fig. 2

Applying KVL to mesh 1,

$$V_s = \left(\frac{z_1}{2} + z_2 \right) I_1 - z_2 I_2$$

Applying KVL to mesh 2,

$$0 = \left(\frac{z_1}{2} + z_2 + z_0 \right) I_2 - z_2 I_1$$

$$z_2 I_1 = \left(\frac{z_1}{2} + z_2 + z_0 \right) I_2$$

$$\frac{I_1}{I_2} = \frac{\left(\frac{z_1}{2} + z_2 + z_0 \right)}{z_2} = e^\gamma$$

$$\frac{z_1}{2} + z_2 + z_0 = z_2 e^\gamma$$

$$z_0 = z_2(e^\gamma - 1) - \frac{z_1}{2}$$

The characteristic impedance of T network is given by

$$z_0 = \sqrt{\frac{z_1^2}{4} + z_1 z_2}$$

$$\sqrt{\frac{z_1^2}{4} + z_1 z_2} = z_2(e^\gamma - 1) - \frac{z_1}{2}$$

$$\frac{z_1^2}{4} + z_1 z_2 = z_2^2(e^\gamma - 1)^2 + \frac{z_1^2}{4} - z_1 z_2(e^\gamma - 1)$$

$$z_2^2(e^\gamma - 1)^2 - z_1 z_2(1 + e^\gamma - 1) = 0$$

$$z_2^2(e^\gamma - 1)^2 - z_1 z_2 e^\gamma = 0$$

$$z_2(e^\gamma - 1)^2 - z_1 e^\gamma = 0$$

$$(e^\gamma - 1)^2 = \frac{z_1}{z_2} e^\gamma$$

$$e^{2\gamma} - 2e^\gamma + 1 = \frac{z_1}{z_2 e^{-\gamma}}$$

$$e^{-\gamma}(e^{2\gamma} - 2e^\gamma + 1) = \frac{z_1}{z_2}$$

$$(e^\gamma + e^{-\gamma} - 2) = \frac{z_1}{z_2}$$

$$\frac{e^\gamma + e^{-\gamma}}{2} = 1 + \frac{z_1}{2z_2}$$

$$\begin{aligned} \cosh \gamma &= 1 + \frac{z_1}{2z_2} \\ \sinh \gamma &= \sqrt{\cosh^2 \gamma - 1} \\ &= \sqrt{\left(1 + \frac{z_1}{2z_2}\right)^2 - 1} \\ &= \sqrt{1 + \frac{z_1}{z_2} + \frac{z_1^2}{4z_2^2} - 1} \\ &= \sqrt{\frac{z_1}{z_2} + \left(\frac{z_1}{2z_2}\right)^2} = \frac{1}{z_2} \sqrt{z_1 z_2 + \frac{z_1^2}{4}} = \frac{z_{OT}}{z_2} \\ \tanh \gamma &= \frac{\sinh \gamma}{\cosh \gamma} \\ &= \frac{z_{OT}}{z_2 + \frac{z_1}{2}} \\ \text{But } z_{OT} &= \sqrt{z_{OC} z_{SC}} \\ \text{and } z_{OC} &= \frac{z_1}{2} + z_2 \\ \tanh \gamma &= \sqrt{\frac{z_{SC}}{z_{OC}}} \end{aligned}$$

π NETWORK

Figure 3 shows π -network.

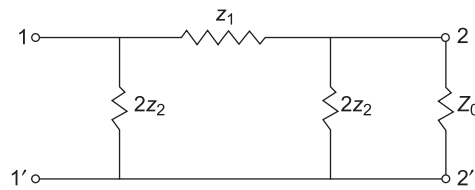

Fig. 3

Characteristic Impedance

For π network, the value of input impedance when it is terminated by impedance z_0 , is given by

$$z_{in} = \frac{2z_2 \left[z_1 + \frac{2z_2 z_0}{2z_2 + z_0} \right]}{z_1 + \frac{2z_2 z_0}{2z_2 + z_0} + 2z_2}$$

But

$$z_{in} = z_0$$

$$z_0 = \frac{2z_2 \left[z_1 + \frac{2z_2 z_0}{2z_2 + z_0} \right]}{z_1 + \frac{2z_2 z_0}{2z_2 + z_0} + 2z_2}$$

$$z_0 z_1 + \frac{2z_2 z_0^2}{2z_2 + z_0} + 2z_0 z_2 = \frac{2z_2(2z_1 z_2 + z_0 z_1 + 2z_0 z_2)}{2z_2 + z_0}$$

$$2z_0 z_1 z_2 + z_1 z_0^2 + 2z_0 z_2^2 + 4z_2 z_0^2 + 2z_2 z_0^2 = 4z_1 z_1^2 + 2z_0 z_1 z_2 + 4z_0 z_2^2$$

$$z_1 z_0^2 + 4z_2 z_0^2 = 4z_1 z_2^2$$

$$z_0^2(z_1 + 4z_2) = 4z_1 z_2^2$$

$$z_0^2 = \frac{4z_1 z_2}{z_1 + 4z_2}$$

$$z_0 = \sqrt{\frac{z_1 z_2}{1 + 4 \frac{z_1}{z_2}}}$$

Hence characteristic impedance of a symmetrical π network is given by

$$z_{0\pi} = \frac{\sqrt{z_1 z_2}}{\sqrt{1 + 4 \frac{z_1}{z_2}}} = \frac{z_1 z_2}{\sqrt{z_1 z_2 + \frac{z_1^2}{4}}}$$

But

$$z_{0T} = \sqrt{\frac{z_1^2}{4} + z_1 z_2}$$

$$z_{0\pi} = \frac{z_1 z_2}{z_{0T}}$$

Characteristic impedance can also be expressed in terms of open circuit impedance z_{OC} and short circuit impedance z_{SC} .

$$\begin{aligned} \text{Open circuit impedance } z_{OC} &= \frac{2z_2(z_1 + 2z_2)}{2z_2 + z_1 + 2z_2} \\ &= \frac{2z_2(z_1 + 2z_2)}{z_1 + 4z_2} \end{aligned}$$

$$\text{Short circuit impedance } z_{SC} = \frac{2z_1 z_2}{2z_2 + z_1}$$

$$z_{OC} z_{SC} = \frac{4z_1 z_2^2}{z_1 + 4z_2} = \frac{z_1 z_2}{1 + \frac{z_1}{4z_2}}$$

$$z_{0\pi} = \sqrt{z_{OC} z_{SC}}$$

Propagation Constant

The propagation constant of a symmetrical π network is same as that of a symmetrical T network.

Characteristic of Filters

A filter transmits or passes desired range of frequencies without loss and attenuates all undesired frequencies. The propagation constant

$$\gamma = \alpha + j\beta$$

where α is attenuation constant and β is the phase constant. We know that

$$\begin{aligned} \sinh \frac{\gamma}{2} &= \sqrt{\frac{z_1}{4z_2}} \\ \sinh \left(\frac{\alpha + j\beta}{2} \right) &= \sinh \frac{\alpha}{2} \cos \frac{\beta}{2} + j \cosh \frac{\alpha}{2} \sin \frac{\beta}{2} \\ &= \sqrt{\frac{z_1}{4z_2}} \end{aligned}$$

Depending upon the type of z_1 and z_2 , these are two cases:

Case (i) If z_1 and z_2 are same type of reactances, then $\left| \frac{z_1}{4z_2} \right|$ is real

$$\begin{aligned} \cosh \frac{\alpha}{2} \sin \frac{\beta}{2} &= 0 \\ \sin \frac{\beta}{2} &= 0 \text{ if } \frac{\beta}{2} = 0 \text{ or } n\pi \text{ where } n = 0, 1, 2, \dots \\ \cos \frac{\beta}{2} &= 1 \\ \sinh \frac{\alpha}{2} &= \sqrt{\frac{z_1}{4z_2}} \\ \alpha &= 2 \sinh^{-1} \sqrt{\frac{z_1}{4z_2}} \end{aligned}$$

Case (ii) If z_1 and z_2 are opposite type of reactances, then $\frac{z_1}{4z_2}$ is negative, i.e. $\left| \frac{z_1}{4z_2} \right| < 0$ and $\left| \frac{z_1}{4z_2} \right|$ is imaginary

$$\begin{aligned} \sinh \frac{\alpha}{2} \cos \frac{\beta}{2} &= 0 \\ \cosh \frac{\alpha}{2} \sin \frac{\beta}{2} &= \sqrt{\frac{z_1}{4z_2}} \end{aligned}$$

Both the above equations must be satisfied simultaneously by α and β . Two conditions may arise

$$(a) \quad \sinh \frac{\alpha}{2} = 0 \quad \text{i.e. } \alpha = 0 \quad \text{when } \beta \neq 0 \quad \text{and } \sin \frac{\beta}{2} = \sqrt{\frac{z_1}{4z_2}} \quad \text{as } \cosh \frac{\alpha}{2} = 1$$

This signifies the region of zero attenuation or pass band which is limited by the upper limit of sine terms.

$$\sin \frac{\beta}{2} = 1$$

$$-1 < \frac{z_1}{4z_2} < 0$$

The phase angle in the pass band

$$\beta = 2 \sin^{-1} \sqrt{\frac{z_1}{4z_2}}$$

$$(b) \quad \cos \frac{\beta}{2} = 0$$

$$\sin \frac{\beta}{2} = \pm 1$$

$$\cosh \frac{\alpha}{2} = \sqrt{\frac{z_1}{4z_2}}$$

This signifies a stop band since $\alpha \neq 0$

$$\alpha = 2 \cosh^{-1} \sqrt{\frac{z_1}{4z_2}}$$

$$\frac{z_1}{4z_2} < -1$$

Constant k filter

In constant k filters, z_1 and z_2 are opposite type of reactances.

$$z_1 z_2 = k^2$$

where k is a constant independent of frequency. There are two types of constant k type filters

- (i) constant k low pass filter
- (ii) constant k high pass filter

Constant k low pass filter

Figure 4 shows constant k low pass filter.

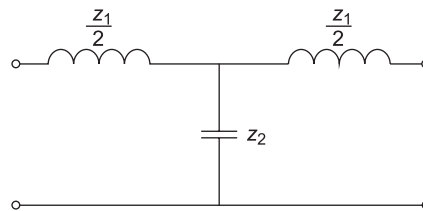

Fig. 4

Let

$$z_1 = j\omega L$$

$$z_2 = \frac{1}{j\omega C} = \frac{-j}{\omega C}$$

$$z_1 z_2 = \frac{L}{C} = k^2$$

$$k = \sqrt{\frac{L}{C}}$$

Determination of pass band and stop band:

(i) when $\frac{z_1}{4z_2} = 0$

$$\frac{j\omega L}{-4j\omega C} = 0$$

$$\frac{-\omega^2 LC}{4} = 0$$

$$\omega = 0$$

$$f = 0$$

(ii) when $\frac{z_1}{4z_2} = -1$

$$\frac{j\omega L}{-4j\omega C} = -1$$

$$\frac{\omega^2 LC}{4} = 1$$

$$\frac{4\pi^2 f^2 LC}{4} = 1$$

$$f = f_c = \frac{1}{\pi \sqrt{LC}}$$

The passband starts at $f = 0$ and continues upto f_c , the cutoff frequency. All the frequencies above.

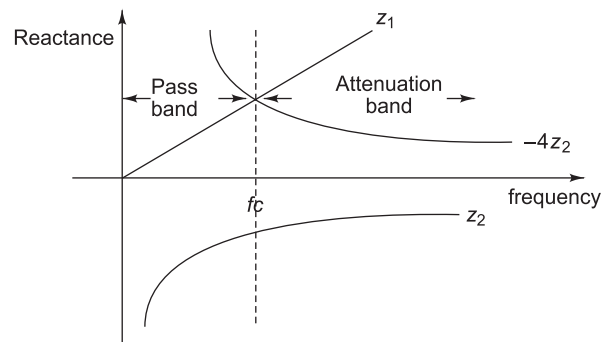

Fig. 5

cutoff frequency f_C are in the attenuation or stop band. Thus, the network is called a low-pass filter.

$$\begin{aligned}\sinh \frac{\gamma}{2} &= \sqrt{\frac{z_1}{4z_2}} = \sqrt{\frac{-\omega^2 LC}{4}} = \frac{j\omega \sqrt{LC}}{2} \\ &= \frac{j2\pi f}{2\pi f_C} = j \frac{f}{f_C}\end{aligned}$$

We also know that in the pass band

$$\begin{aligned}-1 &< \frac{z_1}{4z_2} < 0 \\ -1 &< \frac{-\omega^2 LC}{4} < 0 \\ -1 &< -\left(\frac{f}{f_C}\right)^2 < 0\end{aligned}$$

$$\frac{f}{f_C} < 1$$

$$\beta = 2 \sin^{-1} \left(\frac{f}{f_C} \right)$$

$$\alpha = 0$$

In the attenuation band,

$$\frac{z_1}{4z_2} < -1$$

$$\frac{f}{f_C} > 1$$

$$\alpha = 2 \cosh^{-1} \left(\frac{z_1}{4z_2} \right) = 2 \cosh^{-1} \left(\frac{f}{f_C} \right)$$

$$\beta = \pi$$

The variation of α and β is plotted in the Fig. 6.

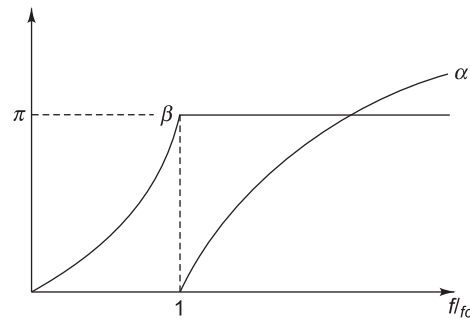

Fig. 6

The attenuation α is zero throughout the pass band but increases gradually from the cutoff frequency. The phase shift β is zero at zero frequency and increases gradually through the pass band, reaches π at cutoff frequency f_C . It remains at π for all frequencies beyond f_C .

Determination of characteristic impedance:

The characteristic impedance of low pass filter will be given by

$$\begin{aligned} z_{0T} &= \sqrt{z_1 z_2 \left(1 + \frac{z_1}{4z_2} \right)} \\ &= \sqrt{\frac{L}{C} \left(1 - \frac{f^2 LC}{4} \right)} \\ &= k \sqrt{1 - \left(\frac{f}{f_C} \right)^2} \\ z_{0\pi} &= \frac{z_1 z_2}{z_{0T}} = \frac{k}{\sqrt{1 - \left(\frac{f}{f_C} \right)^2}} \end{aligned}$$

The plots of characteristic impedance are shown in Fig. 7.

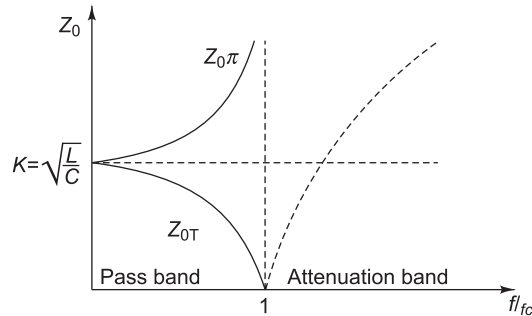

Fig. 7

z_{0T} is real when $f < f_C$ i.e. in the pass band. If $f = f_C$, $z_{0T} = 0$ and for $f > f_C$, z_{0T} is imaginary in the attenuation band, rising to infinite reactance at infinite frequency.

$z_{0\pi}$ is real when $f < f_C$. If $f = f_C$, $z_{0\pi}$ is finite and for $f > f_C$, $z_{0\pi}$ is imaginary.

Design of Filter

A low pass filter can be designed from the specifications of cutoff frequency and load.

At cutoff frequency f_C ,

$$\begin{aligned} \frac{z_1}{4z_2} &= -1 \\ z_1 &= -4z_2 \\ j\omega_C L &= \frac{4}{j\omega_C C} \end{aligned}$$

$$\begin{aligned} \pi^2 f_c^2 LC &= 1 \\ \text{But } k^2 &= \frac{L}{C} \\ \pi^2 f_c^2 k^2 C^2 &= 1 \\ C &= \frac{1}{\pi f_c k} \\ L &= k^2 C = \frac{k}{\pi f_c} \end{aligned}$$

Constant k high pass filter

Constant k high pass filter is obtained by changing the positions of series and shunt arms of the constant k low pass filter. Figure 8 shows a constant k high pass filter.

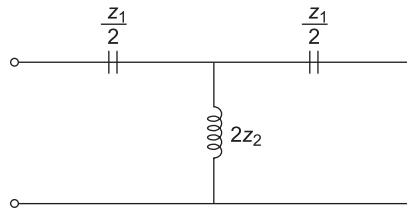

Fig. 8

$$\begin{aligned} \text{Let } z_1 &= \frac{-j}{\omega C} \\ z_2 &= j\omega L \\ z_1 z_2 &= \frac{-j}{\omega C} j\omega L = \frac{L}{C} = k^2 \\ k &= \sqrt{\frac{L}{C}} \end{aligned}$$

Determination of pass band and stop band:

$$\text{(i) when } z_1 = 0$$

$$\frac{-j}{\omega C} = 0$$

$$\omega = \infty$$

$$\text{(ii) when } \frac{z_1}{4z_2} = -1$$

$$z_1 = -4z_2$$

$$\frac{-j}{\omega C} = -4j\omega L$$

$$\omega^2 LC = \frac{1}{4}$$

$$\omega^2 = \frac{1}{4LC}$$

$$f = \frac{1}{4\pi \sqrt{LC}}$$

$$f = f_c = \frac{1}{4\pi \sqrt{LC}}$$

The reactances z_1 and z_2 are shown in Fig. 9.

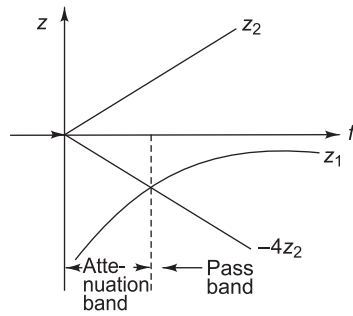

Fig. 9

As seen from Fig. 9 the filter passes all the frequency beyond f_c . All frequencies below the cutoff frequency lie in attenuation or stop band. Hence the network is called a high pass filter.

$$\sinh \frac{\gamma}{2} = \sqrt{\frac{z_1}{4z_2}} = \sqrt{\frac{1}{4\omega^2 LC}}$$

$$= \sqrt{\frac{(4\pi)^2 f_c^2}{4\omega^2}}$$

$$= j \frac{f_c}{f}$$

We know that in pass band

$$-1 < \frac{z_1}{4z_2} < 0$$

$$-1 < -\frac{f_c}{f}$$

$$\frac{f_c}{f} < 1$$

$$\beta = 2 \sin^{-1} \left(\frac{f_c}{f} \right)$$

$$\alpha = 0$$

In the attenuation band

$$\frac{z_1}{4z_2} < -1$$

$$\frac{f_C}{f} > 1$$

$$\alpha = 2 \cosh^{-1} \left(\frac{z_1}{4z_2} \right)$$

$$= 2 \cosh^{-1} \left(\frac{f_C}{f} \right)$$

$$\beta = -\pi.$$

The variation of α and β is plotted in the Fig. 10.

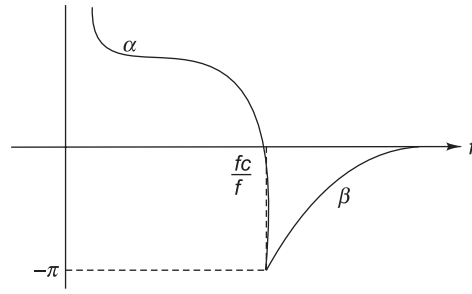

Fig. 10

The phase constant β remains at constant value π in the stop band i.e. in $0 < f < f_C$. The phase constant β increases from π to $-\pi$ at f_C and reaches 0 value gradually as f increases in the pass band. The attenuation constant α is infinity at zero frequency and gradually to zero and remains at zero throughout the passband i.e. in $f_C < f < \infty$.

Determination of Characteristic Impedance

The characteristic impedance will be given by

$$\begin{aligned} z_{0T} &= \sqrt{z_1 z_2 \left(1 + \frac{z_1}{4z_2} \right)} \\ &= \sqrt{\frac{L}{C} \left(1 - \frac{1}{4\theta^2 LC} \right)} \\ &= k \sqrt{1 - \left(\frac{f_C}{f} \right)^2} \end{aligned}$$

Similarly

$$z_{0\pi} = \frac{z_1 z_2}{z_{0T}} = \frac{k^2}{z_{0T}} = \frac{k}{\sqrt{1 - \left(\frac{f_C}{f} \right)^2}}$$

The plots of characteristic impedances are shown in Fig. 11.

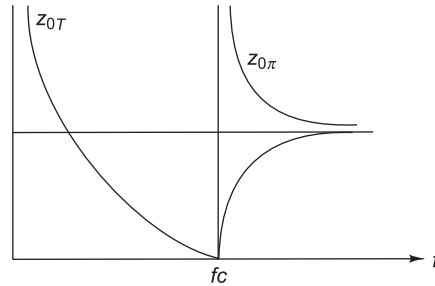

Fig. 11

Design of Filter

A high pass filter can be designed similar to the low pass filter by choosing a resistive load R equal to the constant k such that

$$R = k = \sqrt{\frac{L}{C}}$$

$$f_c = \frac{1}{4\pi \sqrt{LC}}$$

$$f_c = \frac{k}{4\pi L} = \frac{1}{4\pi Ck}$$

Since

$$\sqrt{C} = \frac{L}{k}$$

$$L = \frac{K}{4\pi f_c}$$

$$C = \frac{1}{4\pi f_c k}$$

BAND PASS FILTER

A band pass filter attenuates all frequencies below a lower cutoff frequency and above an upper cutoff frequency. It passes a band of frequencies without attenuation. A band pass filter is obtained by using a low pass filter followed by a high pass filter.

Figure 12 shows a band pass filter. The series arm is a series resonant circuit comprising L_1 and C_1 while its shunt arm is formed by a parallel resonant circuit L_2 and C_2 . The resonant frequency of series arm and shunt arm are made equal.

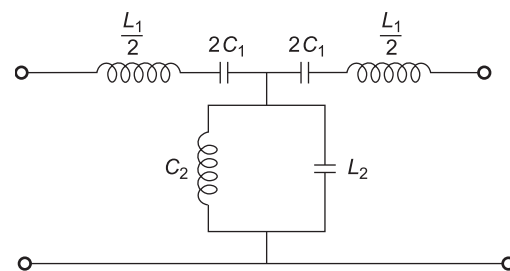

Fig. 12

For this condition,

$$\omega_0 \frac{L_1}{2} = \frac{2}{C_1}$$

$$\omega_0^2 = \frac{1}{L_1 C_1}$$

Also,
$$\frac{1}{C_2} = \omega_0 L_2$$

$$\omega_0^2 = \frac{1}{L_2 C_2}$$

$$L_1 C_1 = L_2 C_2$$

For series arm,

$$\begin{aligned} z_1 &= j\omega L_1 - \frac{j}{C_1} \\ &= j \left(\frac{L_1 C_1 - 1}{C_1} \right) \end{aligned}$$

For shunt arm,

$$\begin{aligned} z_2 &= \frac{j\omega L_2 \frac{1}{C_2}}{j\omega L_2 + \frac{1}{C_2}} = \frac{j\omega L_2}{1 - \omega^2 L_2 C_2} \\ z_1 z_2 &= j \left(\frac{L_1 C_1 - 1}{C_1} \right) \left(\frac{j\omega L_2}{1 - \omega^2 L_2 C_2} \right) \\ &= \frac{L_2}{C_1} \left(\frac{L_1 C_1 - 1}{1 - \omega^2 L_2 C_2} \right) \\ &= \frac{L_2}{C_1} = \frac{L_1}{C_2} = k^2 \end{aligned}$$

where k is constant.

For constant k type filter, at cutoff frequency,

$$\begin{aligned} z_1 &= -4z_2 \\ z_1^2 &= -4z_1 z_2 = -4k^2 \\ z_1 &= \pm j2k \end{aligned}$$

i.e. the z_1 at lower cutoff frequency is equal to the $-z_1$ at the upper cutoff frequency.

$$\begin{aligned} \left(\frac{1}{j\omega C_1} - j\omega L_1 \right) &= j\omega L_2 - \frac{1}{j\omega C_2} \\ 1 - \omega^2 L_1 C_1 &= \frac{1}{\omega^2 L_2 C_2} (\omega^2 L_1 C_1 - 1) \end{aligned}$$

But

$$\omega_0^2 = \frac{1}{L_1 C_1}$$

$$1 - \frac{\omega_1^2}{\omega_0^2} = \frac{\omega_1^2}{\omega_0^2} \left(\frac{\omega_2^2}{\omega_0^2} - 1 \right)$$

$$\begin{aligned} (\omega_0^2 - \omega_1^2) \omega_2 &= \omega_1 (\omega_2^2 - \omega_0^2) \\ \omega_0^2 \omega_2 - \omega_1^2 \omega_2 &= \omega_1 \omega_2^2 - \omega_1 \omega_0^2 \\ \omega_0^2 (\omega_1 + \omega_2) &= \omega_1 \omega_2 (\omega_2 + \omega_1) \\ \omega_0^2 &= \omega_1 \omega_2 \\ f_0 &= \sqrt{f_1 f_2} \end{aligned}$$

Thus resonant frequency is the geometric mean of the cutoff frequencies. The variation of reactances with respect to frequency is shown in Fig. 13

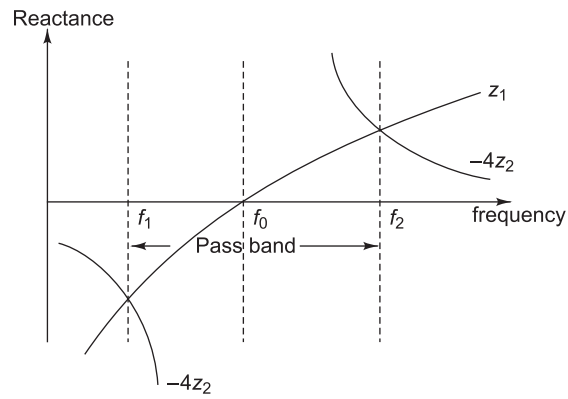

Fig. 13

Design: If the filter is terminated in a load resistance $R = k$, then at lower cutoff frequency

$$z_1 = -2jk$$

$$\left(\frac{1}{j\omega_1 C_1} + j\omega_1 L_1 \right) = -2jk$$

$$\frac{1}{\omega_1 C_1} - \omega_1 L_1 = 2k$$

$$1 - \omega_1^2 L_1 C_1 = 2k\omega_1 C_1$$

$$1 - \frac{\omega_1^2}{\omega_0^2} = 2k\omega_1 C_1$$

$$1 - \left(\frac{f_1}{f_0} \right)^2 = 4\pi k f_1 C_1$$

$$1 - \frac{f_1^2}{f_1 f_2} = 4\pi k f_1 C_1$$

$$f_2 - f_1 = 4\pi k f_1 f_2 C_1$$

$$C_1 = \frac{f_2 - f_1}{4\pi k f_1 f_2}$$

$$L_1 = \frac{1}{\omega_0^2 C_1} = \frac{4\pi k f_1 f_2}{\omega_0^2 (f_2 - f_1)}$$

$$= \frac{k}{\pi (f_2 - f_1)}$$

For shunt arm,

$$z_1 z_2 = \frac{L_2}{C_1} = \frac{L_1}{C_2} = k^2$$

$$L_2 = C_1 k^2 = \frac{(f_2 - f_1)k}{4\pi f_1 f_2}$$

$$C_2 = \frac{L_1}{k^2} = \frac{1}{\pi (f_2 - f_1)k}$$

Band-stop filter

A band stop filter attenuates a specified band of frequencies and permits all frequencies below and above this band. A band stop filter is realized by connecting a low pass filter in parallel with a high pass filter.

Figure 14 shows a bandstop filter.

As in the band pass filter, the series and shunt arms are chosen to resonate at same frequency ω_0 .

For series arm,

$$\frac{\omega_0 L_1}{2} = \frac{1}{2\omega_0 C_1}$$

$$\omega_0^2 = \frac{1}{L_1 C_1}$$

For shunt arm,

$$\omega_0 L_2 = \frac{1}{\omega_0 C_2}$$

$$\omega_0^2 = \frac{1}{L_2 C_2}$$

$$L_1 C_1 = L_2 C_2$$

Similarly

$$z_1 z_2 = \frac{L_1}{C_2} = \frac{L_2}{C_1} = k^2$$

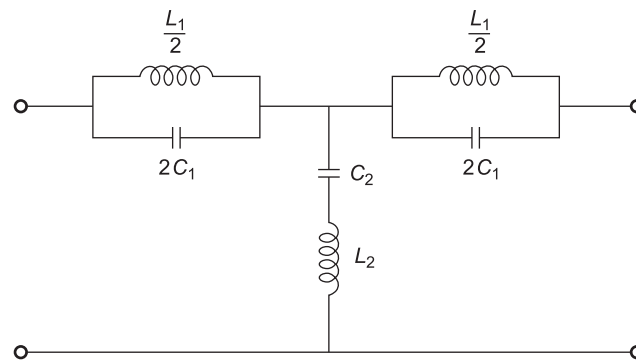

Fig. 14

and $f_0 = \sqrt{f_1 f_2}$
 At cutoff frequencies $z_1 = -4z_2$
 $z_1 z_2 = -4z_2^2 = k^2$
 $z_2 = \pm j \frac{k}{2}$

Design: If the load is terminated in load resistance $R = k$, then at lower cutoff frequency,

$$z_2 = j \left(\frac{1}{\omega_1 C_2} - \omega_1 L_2 \right) = j \frac{k}{2}$$

$$\frac{1}{\omega_1 C_2} - \omega_1 L_2 = \frac{k}{2}$$

$$1 - \omega_1^2 C_2 L_2 = \omega_1 C_2 \frac{k}{2}$$

$$1 - \frac{1}{\omega_1^2} = \frac{k}{2} \omega_1 C_2$$

$$1 - \left(\frac{f_1}{f_0} \right)^2 = k \pi f_1 C_2$$

$$C_2 = \frac{1}{k \pi f_1} \left[1 - \left(\frac{f_1}{f_0} \right)^2 \right]$$

$$= \frac{1}{k \pi} \left[\frac{1}{f_1} - \frac{1}{f_2} \right]$$

$$= \frac{1}{k \pi} \left[\frac{f_2 - f_1}{f_1 f_2} \right]$$

$$L_2 = \frac{1}{\omega_1^2 C_2} = \frac{k f_1 f_2}{\omega_1^2 (f_2 - f_1)}$$

$$= \frac{k}{4 \pi (f_2 - f_1)}$$

$$k^2 = \frac{L_1}{C_2} = \frac{L_2}{C_1}$$

$$L_1 = k^2 C_2 = \frac{k}{\pi} \left(\frac{f_2 - f_1}{f_1 f_2} \right)$$

$$C_1 = \frac{L_2}{k^2} = \frac{1}{4 \pi k (f_2 - f_1)}$$